

Antarctic Automatic Weather Station Data
for the calendar year
1981

by

Michael L. Savage

Charles R. Stearns

David Fleming

Department of Meteorology
The University of Wisconsin
1225 West Dayton Street
Madison, Wisconsin 53706

October 1985

*file
pick*
A

Acknowledgements

Professor Werner Schwerdtfeger of the University of Wisconsin, Professor Robert Renard of the Naval Postgraduate School, and Dr. Benson Fogle of the National Science Foundation were instrumental in the formulation of the Automatic Weather Station (AWS) program. Original AWS were developed by members of the Radioscience Laboratory, Stanford University, under the direction of Dr. Allen M. Peterson, with contributions from M. Sites, C. Teague, F. Orabona, K. Chen, B. Kline, R. Flint and W. Crosby.

AWS units were deployed in the Ross Island area for 1981 by E. Paschal of Stanford University, M. Savage of the University of Wisconsin, and R. Evans, B. Smith and S. Foster of the Naval Support Force Antarctica.

Joseph Bossiere of Expedition Polaries Francaises installed the AWS unit at D-57. These individuals and the numerous members of the U.S. Antarctic Research Program who assisted in this effort are gratefully acknowledged.

Funding for the AWS program has been provided by the United States National Science Foundation, Division of Polar Programs, Grants DPP 79-25040 and DPP 83-06265.

Cover: Locations of the Automatic Weather Stations operating in Antarctica during 1981.

B one side

Table of Contents

	Page
I. Introduction	1
II. Locations and Deployment Summary	2
Fig. 1. Pacific Sector of Antarctica	3
Fig. 2. Ross Island area of Antarctica	4
III. Monthly Climate Summaries	
Byrd	5
Dome C	5
Manning	6
Marble Point	6
Ferrell	7
Asgard	7
Meeley	8
IV. Three-Hourly Data Summaires	
D-10	9
Byrd	14
Dome C	26
Manning	38
Marble Point	50
Ferrell	62
Asgard	74
Laurie	86
Jimmy	87
Meeley	88
D-57	100
V. Field Report	112
VI. Annual Summary Article	147

2

one side

I. Introduction

Automatic Weather Stations (AWS) provide surface weather observations at a number of locations in Antarctica. Data consist of air temperature (degrees Celsius), wind speed (meters per second), and wind direction (true degrees) at approximately three meters above the surface. Data are telemetered via polar-orbiting satellite to McMurdo, Antarctica, and to New Zealand, Australia, and the United States. Data storage design and the geometry of the satellite orbit result in 50 minutes of data at ten minute intervals for each 100 minute orbit of the satellite, yielding between 70 and 144 observations per station per day depending on the number of operational satellites.

Data have been selected at three-hourly intervals (plus or minus one hour) to produce a one page monthly summary for each station. Maximum and minimum values have been selected from the complete data set. It is likely that the AWS underestimate the true maximum winds due to discrete sampling.

Data and further information concerning the AWS program may be obtained by contacting:

Professor Charles R. Stearns
Meteorology Department
1225 West Dayton Street
Madison, Wisconsin 53706
Telephone: (608) 262-0780 / 262-2828

II. Locations and Deployment Summary

New Installations

AWS ID	Location or Name	Lat. (deg)	Long. (deg)	Elev (m)	Start	Stop	Notes
8910	Laurie	77.55 S	170.09 E	23	15 Dec 81		
8911	Jimmy	77.80 S	166.70 E	202	05 Dec 81		
8916	D-57	68.18 S	137.52 E	2103	16 Jan 81		1

Continuing Stations

AWS ID	Location or Name	Lat. (deg)	Long. (deg)	Elev (m)	Start	Stop	Notes
8901	D-10	66.70 S	139.80 E	240	08 Jan 80	23 May 81	2
8903	Byrd	80.00 S	120.00 W	1530	05 Feb 80		
8904	Dome C	74.50 S	123.00 E	3280	05 Feb 80		
8905	Manning	78.77 S	166.85 E	66	01 Dec 80		3
8906	Marble Point	77.43 S	163.75 E	121	05 Feb 80		4
8907	Ferrell	78.02 S	170.80 E	44	10 Dec 80		
8908	Asgard	77.60 S	160.10 E	1750	05 Feb 80		5
8915	Meeley	78.52 S	170.18 E	49	04 Dec 80		

1. Intermittent operation throughout the year.
2. Failed due to corrosion.
3. Repeated freeze-up of wind speed sensor during periods of light winds.
4. Loss of wind speed data beginning 17 May 81 due to broken wire in sensor.
5. Loss of wind speed and direction data beginning 7 June 81 due to over-turned tower.

*** Data missing for all stations for period 1-15 Jan 81 due to loss of data tape.

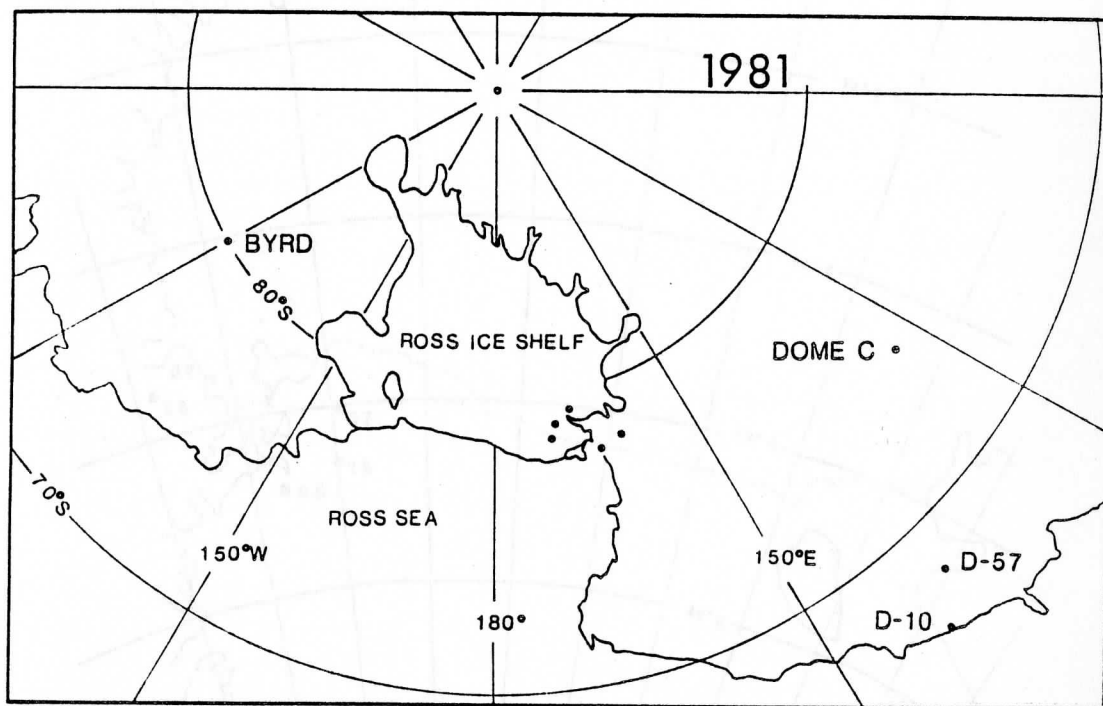

Fig. 1. Pacific sector of Antarctica. AWS units are at Byrd (8903), Dome C (8904), D-10 (8901), and D-57 (8916). The AWS units near Ross Island are shown in Fig. 2.

1981 AWS Locations

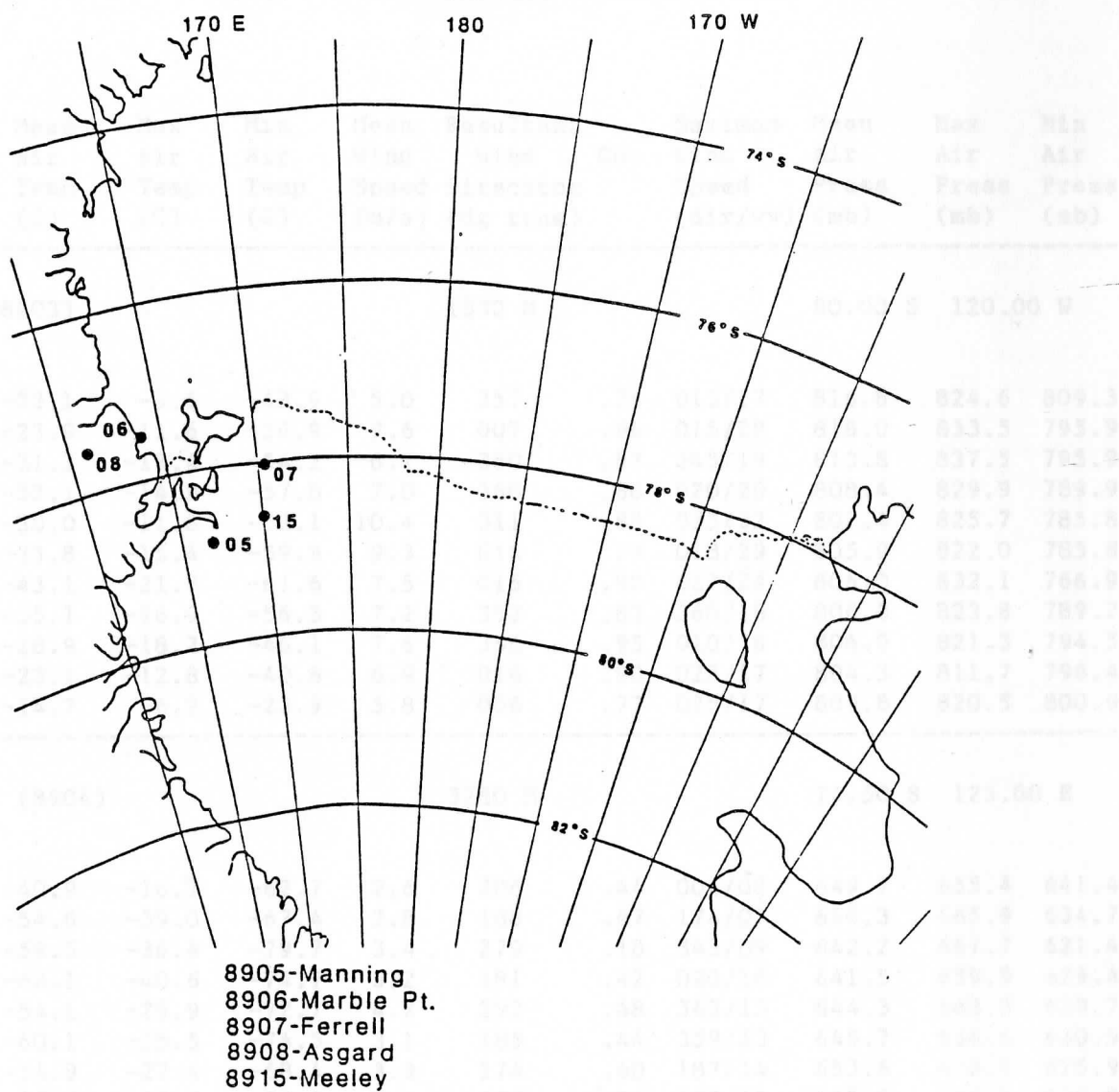

Fig. 2. Ross Island area of Antarctica. The last two digits of the AWS identification number are by the site. Since the AWS unit may be moved from one site to another the sites are named.

III. 1981 - MONTHLY CLIMATE SUMMARY

Mon	Mean Air Temp (C)	Max Air Temp (C)	Min Air Temp (C)	Mean Wind Speed (m/s)	Resultant Wind Direciton (dg true)	Con	Maximum Wind Speed (dir/vv)	Mean Air Press (mb)	Max Air Press (mb)	Min Air Press (mb)

Byrd (8903)	1530 M					80.00 S 120.00 W				
Jan	-15.1	-2.7	-26.9	5.4	360	.90	357/18	814.6	823.4	806.0
Feb	-23.1	-9.6	-43.9	5.0	357	.76	015/17	816.8	824.6	809.3
Mar	-23.9	-11.6	-36.9	9.6	007	.96	015/28	818.0	833.5	795.9
Apr	-31.3	-12.4	-54.2	6.7	350	.87	345/19	813.8	837.5	795.9
May	-32.1	-14.9	-57.8	7.0	360	.88	020/20	808.4	829.9	789.9
Jun	-30.0	-11.8	-52.1	10.4	011	.88	035/32	802.4	825.7	785.8
Jul	-35.8	-15.4	-59.9	9.3	016	.93	018/29	805.9	822.0	785.8
Aug	-43.1	-21.8	-61.6	7.5	015	.90	027/24	806.0	832.1	766.9
Sep	-35.1	-16.9	-56.5	7.2	352	.83	360/18	806.0	823.8	789.2
Oct	-28.9	-18.2	-46.1	7.6	356	.95	010/16	806.0	821.3	794.5
Nov	-23.1	-12.8	-40.8	6.9	014	.90	025/17	804.3	811.7	796.4
Dec	-14.7	-6.2	-25.9	5.8	006	.77	025/17	809.8	820.5	800.9

Dome C (8904)	3280 M					74.50 S 123.00 E				
Jan	-33.6	-20.0	-47.0	3.3	202	.36	046/08	648.3	654.0	640.3
Feb	-40.9	-16.7	-62.7	2.6	206	.44	004/08	649.7	655.4	641.4
Mar	-54.6	-39.0	-67.4	2.8	188	.67	174/07	650.3	665.9	634.7
Apr	-59.5	-36.4	-79.7	3.4	279	.18	343/09	642.2	667.7	621.4
May	-62.1	-40.6	-74.7	3.2	181	.42	090/16	641.5	659.9	629.4
Jun	-54.1	-25.9	-72.7	4.2	292	.48	343/13	644.3	663.3	629.7
Jul	-60.1	-25.5	-74.5	3.1	185	.44	359/13	645.7	664.6	630.9
Aug	-54.9	-27.4	-68.4	3.9	174	.60	187/14	653.6	672.1	625.9
Sep	-55.3	-32.0	-73.7	3.0	175	.53	169/12	642.2	663.1	625.8
Oct	-49.5	-17.6	-72.0	2.7	154	.54	148/14	636.4	651.4	622.2
Nov	-42.7	-23.1	-67.4	3.2	214	.68	184/12	640.7	661.2	628.5
Dec	-31.9	-16.1	-44.5	2.3	207	.66	200/10	645.1	653.1	635.3

* Con = vector avg speed/scaler avg speed

Mon	Mean Air Temp (C)	Max Air Temp (C)	Min Air Temp (C)	Mean Wind Speed (m/s)	Resultant Wind Direction (dg true)	Con	Maximum Wind Speed (dir/vv)	Mean Air Press (mb)	Max Air Press (mb)	Min Air Press (mb)
-----	----------------------------	---------------------------	---------------------------	--------------------------------	---	-----	--------------------------------------	------------------------------	-----------------------------	-----------------------------

1981

Manning (8905)

66 M

78.77 S 166.85 E

Jan	-8.0	2.5	-19.0	4.1	280	.77	231/11	979.3	992.4	968.4
Feb	-14.4	-1.4	-33.7	4.86	265	.83	229/16	985.4	1001.0	974.7
Mar	-18.8	-6.6	-35.5	4.86	265	.81	252/20	987.7	1003.6	964.5
Apr	-33.0	-5.5	-54.7	3.2	273	.60	262/21	989.7	1011.5	960.5
May	-30.2	-15.0	-49.7	4.8	258	.75	248/17	984.1	1009.6	966.5
Jun	-27.2	-13.5	-46.6	3.4	261	.59	239/23	976.6	1000.6	944.6
Jul	-30.3	-14.9	-47.5	3.1	273	.68	240/19	984.5	1000.4	954.7
Aug	-32.3	-13.7	-51.4	2.4	287	.65	252/17	992.9	1024.0	963.5
Sep	-36.4	-17.1	-52.5				243/13	986.4	1002.7	968.0
Oct	-26.7	-9.5	-26.0	1.8	291	.53	252/14	978.0	1000.3	962.8
Nov	-15.8	-4.9	-34.0	3.8	266	.73	242/13	974.2	983.7	952.6
Dec	-6.9	3.4	-14.5	3.7	260	.69	239/13	975.2	988.5	961.6

Marble Point (8906)

121 M

77.43 S 163.75 E

Jan										
Feb	-8.1	.3	-17.4	4.1	172	.70	149/23	978.2	991.0	966.6
Mar	-12.3	-.6	-21.2	3.8	193	.69	228/15	979.9	995.2	959.6
Apr	-23.4	1.0	-39.1	4.2	193	.69	228/24	981.6	1003.4	953.5
May	-21.3	-10.5	-34.5		190	.73		974.5	997.4	959.7
Jun	-19.1	-1.0	-33.2					968.4	992.6	940.0
Jul	-21.4	-6.9	-30.9					976.7	993.4	949.5
Aug	-24.2	-5.4	-36.5					984.5	1013.7	957.5
Sep	-27.9	-14.2	-40.4					977.8	995.9	961.2
Oct	-20.4	-6.7	-33.5					970.4	990.8	955.9
Nov	-11.7	-1.6	-22.0					967.2	976.9	948.0
Dec	-3.9	2.1	-10.2	3.0	111	.12	121/11	969.0	981.0	956.4

Mon	Mean Air Temp (C)	Max Air Temp (C)	Min Air Temp (C)	Mean Wind Speed (m/s)	Resultant Wind Direction (dg true)	Con	Maximum Wind Speed (dir/vv)	Mean Air Press (mb)	Max Air Press (mb)	Min Air Press (mb)
-----	----------------------------	---------------------------	---------------------------	--------------------------------	---	-----	--------------------------------------	------------------------------	-----------------------------	-----------------------------

1981

Ferrell (8907)

44 M

78.02 S 170.80 E

Jan										
Feb	-15.0	-2.6	-32.9	5.1	207	.82	219/16	987.7	1001.3	973.8
Mar	-20.4	-8.4	-33.2	6.3	209	.86	208/19	989.7	1005.2	969.7
Apr	-33.3	-8.8	-55.9	6.3	205	.70	225/28	992.6	1014.0	965.4
May	-31.4	-16.0	-46.2	8.7	205	.89	200/25	984.8	1009.1	964.8
Jun	-29.5	-16.0	-47.6	7.1	216	.83	214/26	978.5	1002.0	946.2
Jul	-33.4	-16.6	-49.0	5.4	220	.79	219/22	987.0	1004.1	956.5
Aug	-36.3	-15.9	-53.4	5.7	208	.76	211/20	995.2	1025.6	965.0
Sep	-37.5	-19.5	-53.1	5.5	203	.81	210/22	988.8	1008.0	968.8
Oct	-27.5	-11.2	-48.1	4.8	214	.73	207/19	980.9	1002.0	966.7
Nov	-17.7	-4.2	-30.5				203/16	977.1	987.7	958.4
Dec	-7.9	4.5	-15.5	4.1	210	.66	217/17	978.6	990.1	964.2

Asgard (Dry Valleys) (8908)

1750 M

77.60 S 160.10 E

Jan	-12.6	-4.9	-18.6	2.4	221	.56	197/11	806.2	816.6	796.3
Feb	-17.7	-3.2	-27.5	2.7	222	.68	212/20	807.6	816.6	801.1
Mar	-20.1	-9.5	-31.4	2.8	219	.91	224/13	807.7	822.5	790.4
Apr	-27.5	-12.0	-43.0					803.1	828.4	778.4
May	-26.8	-19.1	-39.4					799.3	816.2	790.1
Jun	-26.1	-12.6	-40.1					795.5	822.4	774.0
Jul	-27.4	-12.4	-39.7					801.8	817.1	776.9
Aug	-27.1	-16.0	-42.4					807.1	836.4	779.1
Sep	-27.0	-11.9	-38.5					800.2	819.8	788.8
Oct	-23.5	-10.2	-37.0					796.6	809.9	785.6
Nov	-18.9	-8.1	-30.4					797.0	807.5	779.6
Dec	-12.5	-6.4	-16.2	2.7	187	.60	180/13	802.6	812.3	792.6

Mon	Mean Air Temp (C)	Max Air Temp (C)	Min Air Temp (C)	Mean Wind Speed (m/s)	Resultant Wind Direction (dg true)	Con	Maximim Wind Speed (dir/vv)	Mean Air Press (mb)	Max Air Press (mb)	Min Air Press (mb)
-----	----------------------------	---------------------------	---------------------------	--------------------------------	---	-----	--------------------------------------	------------------------------	-----------------------------	-----------------------------

1981

Meeley (8915)

49 M

78.52 S 170.18 E

Jan	-9.2	-1.6	-17.5	4.4	223	.85	218/12	981.6	993.6	972.2
Feb	-14.9	-3.0	-32.0	5.8	214	.85	231/16	987.0	1000.7	974.2
Mar	-20.4	-9.1	-35.5	7.2	212	.90	217/21	988.9	1004.8	967.9
Apr	-35.0	-8.0	-55.4	4.3	215	.81	225/29	991.4	1013.2	965.2
May	-31.2	-15.2	-45.6	8.4	211	.93	217/24	984.12	1008.6	964.0
Jun	-28.6	-15.6	-45.4	7.7	215	.88	222/24	977.5	1001.0	945.6
Jul	-33.0	-16.9	-48.4	5.4	215	.90	215/24	985.8	1002.9	953.8
Aug	-36.4	-15.5	-52.0	5.2	210	.82	221/21	994.2	1025.0	963.3
Sep	-37.6	-20.2	-54.5	5.5	210	.83	217/20	987.9	1006.7	967.9
Oct	-27.2	-11.7	-47.5	4.8	223	.81	211/20	979.8	1000.5	965.1
Nov	-17.6	-4.0	-31.7	5.3	218		221/16	975.9	986.8	955.2
Dec	-7.9	1.6	-14.9	4.2	214	.70	224/14	977.8	989.5	962.3

STATION : 8901 D-10 LAT : 66.7 S LONG : 139.8E ELEVATION : 240 M

JAN	IR	PP	TT	VV	DD	PP	TT	VV	DD	PP	TT	VV	DD	PP	TT	VV	DD	PP	TT	VV	DD	PP	TT	VV	DD
			DAY 1				DAY 2				DAY 3				DAY 4				DAY 5			DAY 6			
			DAY 8				DAY 9				DAY 10				DAY 11				DAY 12			DAY 13			
			DAY 15				DAY 16				DAY 17				DAY 18				DAY 19			DAY 20			
			DAY 22				DAY 23				DAY 24				DAY 25				DAY 26			DAY 27			
			DAY 29				DAY 30				DAY 31														

MONTHLY SUMMARY

* TEMPERATURE (C) * MEAN = -4.4 STD DEV = 3.4 MAX = 5.1 AT 443 GMT ON DAY 25 MIN = -10.6 AT 1605 GMT ON DAY 19
 * PRESSURE (MB) * MEAN = 950.9 STD DEV = 7.2 MAX = 965.9 AT 2337 GMT ON DAY 19 MIN = 938.4 AT 2034 GMT ON DAY 23
 * WINDS (M/S) * MEAN = 7.1 STD DEV = 4.1 RESULTANT = 6.6 FROM 164. CONSTANCY = .93 MAX = 23.1 FROM 167. AT 1846 GMT DAY 22
 * MISSING 3-HOURLY OBSERVATIONS * TEMPERATURE: 52.0 % PRESSURE: 52.0 % WINDS: 52.0 %
 WIND SPEED (M/S): 0-2 2-4 4-6 6-8 8-10 10-12 12-14 14-16 16-18 18-20 20-25 25-30 30-35 35-40 40-45 45-50 50-55 55-60 60+
 PERCENT: 10 13 16 22 15 3 0 0 3 3 0 0 0 0 0 0 0 0 0 0 0 0 0 0 0 0 0
 WIND DIRECTION: N NNE NE E ESE SE SSE S SSW SW W WSW WNW NNW NW NNW 0

STATION : 8904 DOME C LAT : 74.5 S LONG : 123.0E ELEVATION : 3280 M

HR	PP	TT	VV	DD	PP	TT	VV	DD	PP	TT	VV	DD	PP	TT	VV	DD	PP	TT	VV	DD	PP	TT	VV	DD
00	649	-33	1	180	647	-39	1	120	644	-38	3	45	655	-32	5	3	652	-25	0	0	654	-34	3	141
03	649	-32	1	180	646	-33	2	86	644	-34	7	41	655	-29	2	360	651	-17	0	0	654	-33	4	141
06	649	-30	0	0	646	-33	3	12	645	-32	5	4	655	-29	3	360	650	-27	1	225	655	-33	3	129
09	649	-36	1	174	645	-36	3	54	647	-32	2	360	654	-28	2	360	651	-25	0	0	655	-36	2	143
12	648	-39	1	162	645	-41	3	63	648	-40	2	360	655	-35	2	360	651	-34	3	141	654	-42	2	141
15	648	-46	2	180	644	-43	2	60	649	-43	3	359	655	-40	2	54	651	-40	2	135	654	-48	2	141
18	648	-45	1	180	644	-44	3	68	650	-40	3	7	652	-40	3	270	652	-44	2	141	654	-48	3	167
21	647	-45	0	0	644	-43	3	69	652	-39	2	13	655	-33	2	45	653	-40	3	150	654	-45	2	180
00	653	-40	2	180	650	-38	2	243	652	-36	6	240	654	-36	4	226	652	-34	3	225	653	-35	3	270
03	653	-34	2	180	649	-36	3	260	653	-33	6	238	653	-32	5	224	651	-31	4	222	653	-31	4	270
06	652	-32	2	197	650	-33	4	270	653	-30	6	225	651	-29	4	236	653	-30	5	260	648	-31	2	235
09	652	-35	1	218	650	-34	5	277	654	-33	4	225	652	-33	4	225	651	-32	3	225	653	-32	4	270
12	651	-43	3	224	650	-38	5	270	654	-37	3	249	652	-39	3	225	651	-39	2	270	653	-38	4	270
15	651	-47	3	225	650	-43	4	270	654	-42	3	225	651	-43	2	270	652	-42	3	270	646	-44	2	180
18	650	-48	2	225	651	-47	4	260	654	-42	3	225	652	-42	3	242	651	-47	3	235	646	-46	2	180
21	650	-48	2	240	652	-46	4	270	654	-40	4	225	652	-44	2	289	652	-41	3	246	646	-44	1	160
00	645	-40	1	180	644	-44	2	180	642	-47	2	167	643	-45	0	0	648	-42	3	32	652	-35	1	360
03	645	-35	3	173	644	-38	3	180	642	-39	3	170	644	-38	1	135	649	-34	3	45	652	-32	1	354
06	645	-34	2	203	643	-35	3	180	642	-36	1	173	644	-35	1	90	649	-31	3	11	652	-20	0	0
09	645	-36	2	217	643	-37	2	201	642	-38	1	180	645	-39	2	93	650	-38	3	45	652	-37	1	120
12	645	-44	2	225	643	-45	2	180	642	-45	2	183	645	-44	2	90	650	-44	3	30	653	-41	2	141
15	644	-47	3	212	642	-50	2	180	642	-50	2	180	646	-43	3	94	651	-42	2	3	653	-46	2	155
18	644	-52	2	225	642	-55	2	187	642	-55	1	180	646	-45	3	90	651	-42	1	360	653	-50	2	165
21	644	-51	2	225	641	-55	2	180	642	-55	1	153	647	-46	3	45	651	-41	1	360	652	-51	2	180
00	648	-49	3	245	644	-47	3	186	649	-46	0	0	652	-42	1	180	653	-42	1	180	650	-56	3	225
03	647	-42	4	231	645	-42	2	189	650	-42	1	101	652	-34	2	360	653	-38	0	0	651	-48	5	225
06	646	-41	4	245	646	-39	3	170	650	-41	1	90	653	-36	2	210	651	-45	5	225	652	-45	5	180
09	646	-41	4	235	647	-40	2	180	650	-40	1	80	653	-38	1	90	652	-40	3	221	651	-46	4	210
12	645	-44	3	225	648	-46	2	152	651	-44	2	98	653	-43	3	23	652	-47	3	225	651	-50	4	198
15	644	-47	3	225	648	-52	1	161	650	-48	2	72	653	-43	0	0	652	-54	3	225	650	-54	5	190
18	644	-49	3	221	648	-57	2	141	651	-47	1	79	653	-42	1	111	651	-61	2	225	649	-58	4	180
21	643	-52	2	210	648	-58	1	134	651	-47	2	12	653	-47	2	166	650	-61	3	214	649	-59	4	190

MONTHLY SUMMARY

* TEMPERATURE (C) * MEAN = -40.9 STD DEV = 7.8 MAX = -16.7 AT 243 GMT ON DAY 4 MIN = -62.7 AT 2011 GMT ON DAY 26
 * PRESSURE (MB) * MEAN = 649.7 STD DEV = 3.7 MAX = 655.4 AT 2108 GMT ON DAY 4 MIN = 641.4 AT 2232 GMT ON DAY 16
 * WINDS (M/S) * MEAN = 2.6 STD DEV = 1.4 RESULTANT = 1.1 FROM 206. CONSTANCY = .44 MAX = 7.8 FROM 4. AT 447 GMT DAY 3
 * MISSING 3-HOURLY OBSERVATIONS * TEMPERATURE: 1.8 % PRESSURE: .0 % WINDS: .0 %
 WIND SPEED (M/S): 0-2 2-4 4-6 6-8 8-10 10-12 12-14 14-16 16-18 18-20 20-25 25-30 30-35 35-40 40-45 45-50 50-55 55-60 60+
 PERCENT: 35 50 14 1 0
 WIND DIRECTION: N NNE NE E ESE SE SSE S SSW W WNW NNW
 PERCENT 8 3 4 4 6 1 6 5 23 4 21 5 9 0 0 0 0 0 0 0 0 0 0 0 0

STATION : 8905 MANNING (ICE SHELF - S) LAT : 78.8 S LONG : 167.0E ELEVATION : 66 M

HR	PP	TT	VV	DD	PP	TT	VV	DD	PP	TT	VV	DD	PP	TT	VV	DD	PP	TT	VV	DD	PP	TT	VV	DD	PP	TT	VV	DD				
00	967	-15	1	41	966	-20	7	62	974	-25	6	267	976	-20	6	285	970	-11	2	304	975	-23	7	253	975	-23	7	295	958	-15	10	273
03	967	-18	3	79	965	-21	1	87	975	-20	8	274	976	-19	5	285	970	-10	2	262	972	-11	4	90	975	-11	4	273	974	-13	8	274
06	968	-18	3	278	964	-23	1	328	976	-22	8	243	975	-20	0	0	971	-13	7	301	971	-11	9	69	976	-23	7	297	974	-23	8	274
09	969	-23	0	0	964	-28	0	0	976	-21	0	0	975	-20	5	257	974	-15	7	266	972	-13	2	35	976	-25	6	300	954	-13	9	269
12	970	-21	0	0	965	-30	3	302	977	-21	2	269	974	-20	0	0	974	-15	7	266	973	-17	1	96	977	-25	5	271	954	-17	0	0
15	969	-26	1	111	967	-32	3	312	978	-21	5	256	974	-21	5	277	977	-25	6	278	965	-24	5	274	977	-25	6	278	956	-17	0	0
18	968	-24	6	87	969	-31	0	0	977	-22	4	311	974	-21	4	260	977	-25	5	301	963	-19	8	266	977	-25	5	301	956	-15	3	278
21	967	-21	2	360	972	-24	0	0	977	-23	7	274	975	-23	7	257	976	-24	5	280	961	-17	8	274	976	-24	5	280	958	-15	3	298
00	960	-14	1	263	977	-17	2	118	977	-15	5	208	973	-11	12	257	970	-11	2	304	975	-11	2	300	970	-11	2	300	980	-16	6	307
03	963	-15	0	0	977	-16	1	32	976	-13	0	0	975	-14	10	222	970	-10	2	262	972	-11	4	90	970	-10	2	262	980	-15	3	274
06	966	-19	2	263	977	-18	3	301	975	-14	0	0	974	-13	0	0	971	-13	7	301	971	-11	9	69	971	-13	7	301	980	-13	0	0
09	969	-18	4	304	978	-20	1	333	973	-13	5	257	975	-15	0	0	974	-15	7	266	972	-13	2	35	974	-15	7	266	980	-17	1	277
12	971	-19	0	0	978	-26	2	302	974	-17	0	0	974	-20	3	284	977	-18	8	269	973	-17	1	96	977	-18	8	269	981	-23	2	52
15	973	-20	0	0	978	-26	3	316	973	-14	1	242	973	-17	6	283	977	-17	10	271	975	-21	1	311	977	-17	10	271	981	-21	1	41
18	975	-19	0	0	978	-19	0	0	973	-15	5	257	972	-16	4	271	977	-16	6	263	977	-18	5	312	977	-16	6	263	981	-23	2	309
21	976	-18	2	285	977	-16	5	309	973	-12	3	256	971	-13	0	0	977	-15	4	266	979	-17	5	301	977	-15	4	266	981	-21	2	276
00	981	-17	0	0	976	-17	0	0	979	-16	0	0	984	-14	0	0	979	-11	0	0	972	-14	0	0	970	-11	0	0	974	-14	0	0
03	980	-9	0	0	975	-15	1	301	980	-14	1	280	983	-11	0	0	977	X	0	0	972	-15	5	304	977	X	0	0	975	-11	4	273
06	979	-17	2	120	975	-15	0	0	980	-15	1	319	982	-14	0	0	976	-12	1	6	972	-14	4	283	976	-12	1	6	972	-12	0	0
09	978	-19	4	76	975	-16	0	0	981	-16	0	0	982	-18	1	93	974	-14	0	0	972	-16	0	0	974	-14	0	0	975	-12	5	319
12	978	-23	0	0	975	-17	0	0	982	-22	2	73	982	-21	0	0	974	-18	1	335	973	-20	1	80	975	-12	5	319	975	-12	5	319
15	977	-19	1	4	976	-21	3	307	982	-23	4	77	981	-20	0	0	973	-22	3	315	973	-23	1	37	973	-22	3	315	975	-13	5	301
18	976	-24	1	217	977	-23	1	291	983	-19	2	69	981	-17	0	0	973	-21	0	0	973	-23	1	37	973	-21	0	0	975	-14	6	245
21	976	-21	2	297	978	-17	1	273	984	-14	0	0	980	-14	1	340	973	-16	1	288	974	-18	3	49	977	-16	1	288	977	-17	6	243
00	976	-11	9	252	974	-10	0	0	975	-11	0	0	971	-8	9	242	973	-16	1	288	974	-18	3	56	973	-16	1	288	977	-15	4	287
03	976	-11	8	249	974	-11	1	300	974	-10	4	294	971	-8	10	245	975	-9	0	0	977	-8	5	239	975	-9	0	0	974	-7	7	245
06	977	-11	6	246	973	-12	2	298	973	-10	0	0	972	-8	10	205	975	-9	4	217	976	-7	0	0	976	-7	0	0	973	-7	11	248
09	976	-14	2	262	973	-15	4	301	972	-12	7	314	972	-8	10	205	977	-10	6	238	975	-7	10	235	975	-7	10	235	974	-8	7	238
12	976	-15	0	0	974	-17	3	290	972	-13	5	298	973	-10	9	205	978	-10	9	243	975	-10	7	243	978	-10	9	243	973	-8	8	248
15	975	-16	3	80	974	-17	2	274	971	-13	6	252	976	-17	4	242	978	-11	3	255	975	-12	8	240	975	-12	8	240	974	-10	9	252
18	975	-15	3	83	974	-20	3	285	971	-11	9	249	976	-16	4	233	977	-11	7	257	975	-12	8	259	977	-11	7	257	975	-10	8	248
21	974	-13	3	156	975	-16	3	298	971	-9	8	256	976	-15	2	239	977	-10	1	228	975	-12	7	264	977	-10	1	228	976	-9	10	263
00	977	-7	9	260	981	-7	8	248	971	-9	8	256	974	-10	2	307	976	-9	7	235	974	-9	7	235	976	-9	7	235	974	-8	10	248
03	978	-7	4	245	980	-7	7	238	974	-10	4	294	971	-8	10	245	975	-9	4	217	977	-8	5	239	975	-9	4	217	974	-7	7	245
06	979	-7	10	245	980	-5	2	297	973	-12	2	298	972	-8	10	205	977	-10	6	238	976	-7	10	235	976	-7	10	235	973	-7	11	248
09	980	-7	10	252	978	-8	2	307	973	-15	4	301	972	-8	10	205	978	-10	6	238	975	-7	10	235	975	-7	10	235	974	-8	7	238
12	980	-7	9	256	978	-8	2	307	972	-12	7	314	973	-10	9	205	978	-10	9	243	975	-10	7	243	978	-10	9	243	973	-8	8	248
15	980	-8	10	263	976	-11	3	83	972	-13	5	298	976	-17	4	242	978	-11	3	255	975	-12	8	240	975	-12	8	240	974	-10	9	252
18	981	-9	9	256	974	-17	2	274	971	-11	6	252	976	-16	4	233	977	-11	7	257	975	-12	8	259	977	-11	7	257	975	-10	8	248
21	981	-8	11	263	976	-12	3	97	971	-11	9	249	976	-15	2	239	977	-10	1	228	975	-12	8	259	977	-10	1	228	976	-9	10	263
00	977	-7	9	260	981	-7	8	248	971	-9	8	256	974	-10	2	307	976	-9	7	235	974	-9	7	235	976	-9	7	235	974	-8	10	248
03	978	-7	4	245	980	-7	7	238	974	-10	4	294	971	-8	10	245	975	-9	4	217	977	-8	5	239	975	-9	4	217	974	-7	7	245
06	979	-7	10	245	980	-5	2	297	973	-12	2	298	972	-8	10	205	977	-10	6	238	976	-7	10	235	975	-7	10	235	973	-7	11	248
09	980	-7	10	252	978	-8	2	307	972	-12	7	314	973	-10	9	205	978	-10	9	243	975	-10	7	243	975	-10	7	243	974	-8	8	248
12	980	-7	9	256	978	-8	2	307	972	-12	7	314	973	-10	9	205	978	-10	9	243	975	-10	7	243	975	-10	7	243	973	-8	8	248
15	980	-8	10	263	976	-11	3	83	972	-13	5	298	976	-17	4	242	978	-11	3	255	975	-12	8	240	975	-12	8	240	974	-10	9	252
18	981	-9	9	256	974	-17	2	274	971	-11	6	252	976	-16	4	233	977	-11	7	257	975	-12	8	259	977	-11	7	257	975	-10	8	248
21	981	-8	11	263	976	-12	3	97	971	-11	9	249	976	-15	2	239	977	-10	1	228	975	-12	8	259	977	-10	1	228	976	-9	10	263
00	977	-7	9	260	981	-7	8	248	971	-9	8	256	974	-10	2	307	976	-9	7	235	974	-9	7	235	976	-9	7	235	974	-8	10	248
03	978	-7	4	245	980	-7	7	238	974	-10	4	294	971	-8	10	245	975	-9	4	217	977	-8	5	239	975	-9	4	217	974	-7	7	245
06	979	-7	10	245	980	-5	2	297																								

STATION : 8908 ASGARD, DRY VALLEYS LAT : 77.6 S LONG : 160.1E ELEVATION : 1750 M

HR	PP	TT	VV	DD	PP	TT	VV	DD	PP	TT	VV	DD	PP	TT	VV	DD	PP	TT	VV	DD	PP	TT	VV	DD			
00	806	-30	X	36	808	-28	X	135	802	-25	X	56	794	-28	X	117	X	X	X	794	-20	X	90	803	-17	X	207
03	805	-30	X	45	809	-27	X	360	800	-25	X	100	794	-27	X	90	796	-27	X	795	-20	X	180	804	-17	X	146
06	805	-31	X	148	810	-28	X	135	798	-30	X	90	795	-30	X	360	796	-27	X	795	-19	X	162	805	-17	X	315
09	804	-37	X	109	810	-33	X	108	797	-34	X	326	795	-32	X	315	795	-26	X	797	-19	X	360	807	-20	X	360
12	804	-37	X	117	809	-33	X	71	795	-34	X	75	796	-32	X	179	794	-24	X	798	-19	X	291	807	-20	X	201
15	804	-35	X	71	808	-33	X	118	794	-33	X	270	796	-32	X	333	799	-19	X	799	-19	X	136	808	-20	X	44
18	805	-34	X	117	806	-33	X	135	794	-32	X	339	797	-31	X	340	800	-19	X	800	-19	X	90	809	-20	X	91
21	807	-34	X	150	804	-27	X	135	793	-31	X	129	794	-21	X	308	794	-21	X	801	-17	X	154	809	-16	X	360

STATION : 8916 D-57 LAT : 68.2 S LONG : 137.5E ELEVATION : 2103 M

APR 81	HR	PP	TT	VV	DD	PP	TT	VV	DD	PP	TT	VV	DD	PP	TT	VV	DD	PP	TT	VV	DD	PP	TT	VV	DD	
	00	751	-38	X	14	180	760	-33	12	170	768	-25	12	141	777	-24	11	141	767	-25	14	141	759	-24	15	141
	03	X	X	X	X	X	769	-24	11	131	X	X	X	X	X	X	X	X	X	X	X	X	759	-24	18	134
	06	755	-34	X	12	180	770	-23	12	141	773	-22	12	141	777	-24	10	180	X	X	X	X	759	-23	15	141
	09	756	-35	12	180	756	-28	15	141	771	-23	12	141	776	-26	9	180	763	-27	15	141	760	-23	15	141	
	12	758	-36	11	172	757	-27	16	141	771	-23	14	141	775	-24	13	138	762	-28	15	141	761	-23	16	141	
	15	760	-36	12	170	760	-27	14	141	771	-24	15	141	776	-24	12	172	761	-27	15	134	762	-24	16	141	
	18	760	-36	12	173	763	-27	13	142	771	-24	15	141	776	-26	11	141	760	-26	18	136	763	-25	13	129	
	21	760	-38	11	180	766	-28	13	141	771	-24	16	136	777	-26	11	141	760	-25	16	141	765	-26	15	127	
	00	766	-24	12	141	767	-25	2	207	762	-31	7	180	763	-33	12	180	X	X	X	X	740	-36	12	167	
	03	X	X	X	X	X	X	X	X	X	X	X	X	X	X	X	X	X	X	X	X	X	X	X	X	
	06	768	-23	8	141	765	-27	8	180	X	X	X	X	X	X	X	X	X	X	X	X	X	X	X	X	
	09	769	-24	6	134	765	-30	7	180	761	-39	13	170	762	-34	12	161	X	X	X	X	741	-34	8	149	
	12	769	-23	5	141	765	-29	6	174	762	-41	15	179	761	-33	15	141	X	X	X	X	742	-35	7	160	
	15	769	-23	5	141	764	-28	0	0	762	-40	15	174	X	X	X	X	X	X	X	X	742	-35	5	156	
	18	768	-23	3	141	764	-29	3	210	763	-38	15	172	X	X	X	X	X	X	X	X	742	-36	5	141	
	21	768	-23	3	188	763	-29	2	198	763	-35	14	180	X	X	X	X	X	X	X	X	742	-39	5	161	
	00	748	-30	3	141	748	-30	7	141	736	-31	12	141	X	X	X	X	X	X	X	X	X	X	X	X	
	03	X	X	X	X	X	748	-28	7	134	X	X	X	X	X	X	X	X	X	X	X	X	X	X	X	
	06	X	X	X	X	X	X	X	X	734	-31	11	141	X	X	X	X	X	X	X	X	X	X	X	X	
	09	749	-30	4	141	745	-27	7	141	734	-31	11	143	X	X	X	X	X	X	X	X	X	X	X		
	12	750	-29	4	141	743	-30	10	141	733	-31	15	141	X	X	X	X	X	X	X	X	X	X	X		
	15	750	-28	5	134	741	-29	10	141	X	X	X	X	X	X	X	X	X	X	X	X	X	X	X		
	18	749	-29	5	135	739	-30	10	145	X	X	X	X	X	X	X	X	X	X	X	X	X	X	X		
	21	749	-33	4	141	737	-32	10	139	X	X	X	X	X	X	X	X	X	X	X	X	X	X	X		
	00	X	X	X	X	X	X	X	X	X	X	X	X	X	X	X	X	X	X	X	X	X	X	X	X	
	03	X	X	X	X	X	X	X	X	X	X	X	X	X	X	X	X	X	X	X	X	X	X	X	X	
	06	X	X	X	X	X	X	X	X	X	X	X	X	X	X	X	X	X	X	X	X	X	X	X	X	
	09	X	X	X	X	X	X	X	X	X	X	X	X	X	X	X	X	X	X	X	X	X	X	X	X	
	12	X	X	X	X	X	X	X	X	X	X	X	X	X	X	X	X	X	X	X	X	X	X	X	X	
	15	X	X	X	X	X	X	X	X	X	X	X	X	X	X	X	X	X	X	X	X	X	X	X	X	
	18	X	X	X	X	X	X	X	X	X	X	X	X	X	X	X	X	X	X	X	X	X	X	X	X	
	21	X	X	X	X	X	X	X	X	X	X	X	X	X	X	X	X	X	X	X	X	X	X	X	X	
	00	X	X	X	X	X	X	X	X	X	X	X	X	X	X	X	X	X	X	X	X	X	X	X	X	
	03	X	X	X	X	X	X	X	X	X	X	X	X	X	X	X	X	X	X	X	X	X	X	X	X	
	06	X	X	X	X	X	X	X	X	X	X	X	X	X	X	X	X	X	X	X	X	X	X	X	X	
	09	X	X	X	X	X	X	X	X	X	X	X	X	X	X	X	X	X	X	X	X	X	X	X	X	
	12	X	X	X	X	X	X	X	X	X	X	X	X	X	X	X	X	X	X	X	X	X	X	X	X	
	15	X	X	X	X	X	X	X	X	X	X	X	X	X	X	X	X	X	X	X	X	X	X	X	X	
	18	X	X	X	X	X	X	X	X	X	X	X	X	X	X	X	X	X	X	X	X	X	X	X	X	
	21	X	X	X	X	X	X	X	X	X	X	X	X	X	X	X	X	X	X	X	X	X	X	X	X	

MONTHLY SUMMARY
 * TEMPERATURE (C) * MEAN = -29.4 STD DEV = 5.5 MAX = -22.1 AT 152 GMT ON DAY 4 MIN = -41.6 AT 916 GMT ON DAY 14
 * PRESSURE (MB) * MEAN = 758.6 STD DEV = 11.8 MAX = 777.4 AT 39 GMT ON DAY 5 MIN = 731.7 AT 1538 GMT ON DAY 17
 * WINDS (M/S) * MEAN = 10.7 STD DEV = 4.5 RESULTANT = 9.7 FROM 150. CONSTANCY = .91 MAX = 21.7 FROM 148. AT 1925 GMT DAY 11
 * MISSING 3-HOURLY OBSERVATIONS * TEMPERATURE: 56.3 % PRESSURE: 56.7 % WINDS: 55.4 %
 WIND SPEED (M/S): 0-2 2-4 4-6 6-8 8-10 10-12 12-14 14-16 16-18 18-20 20-25 25-30 30-35 35-40 40-45 45-50 50-55 55-60 60+
 WIND DIRECTION: N NNE NE E ESE SE SSE S SSW SW W WNW NNW
 PERCENT 1 1 0 0 0 0 58 21 6 1 0 0 0 0 0 0 0 0 0 0 0 0 0 0 0 0

V. Field Report

Field Report

Antarctic Automatic Weather Stations

November - December 1980

prepared by

Michael L. Savage

University of Wisconsin-Madison

January 1981

NO BACKUP

TABLE OF CONTENTS

	Page
I. Introduction	114
II. Field Work	
1. Dome Charlie Station	122
2. Manning Station	124
3. Byrd Station	126
4. Meeley Station	128
5. Marble Point Station	130
6. Asgard Station	132
7. Ferrell Station	134
III. Surveying Procedures	136
IV. Installation Procedures	138
V. Aerovanes	140
VI. Equipment	141
VII. Inventory	143
VIII. Notes on AWS Calibration Data	144
IX. Recommendations	146

I. INTRODUCTION

Prior to the 1980-81 austral summer season there were six operational AWS (Automatic Weather Station) units in Antarctica: Byrd, Dome Charlie, D-10 and D-17 near Dumont d'Urville, and Asgard and Marble Point in the Dry Valleys area west of McMurdo. D-10 and D-17 are powered by batteries while the remaining stations are powered by RTG's (radio-isotope thermoelectric generators). These stations measure atmospheric pressure, temperature, wind speed, and wind direction and transmit the data to polar-orbiting satellites which then relay the information to the United States for distribution to users.

During the 1980-81 season three new stations were installed on the Ross Ice Shelf, each at a distance of about 100 kilometers from McMurdo Station. Also, the AWS units at Dome Charlie, Byrd, Asgard, and Marble Point were visited for the purposes of conducting the annual radiation survey of the RTG's, replacement of the aerovanes, and calibration checks of the measured parameters. Additionally, a receiving system was installed in the McMurdo Weather Office in order to provide local access to the AWS data for use in forecast operations.

Figures 1, 2, and 3 illustrate the current and proposed deployment of AWS units in Antarctica (except for the proposed deployment in the Dumont d'Urville region). Tables

1, 2, and 3 provide a summary of pertinent data.

Participants included the following: Dr. John Katsufakis and Ev Paschal from Stanford University, Lt. Commander Brad Smith and Lt. Bob Evans from the U.S. Navy Operation Deepfreeze Weather Office, and Dr. Charles Stearns (Principal Investigator) and the author from the University of Wisconsin at Madison.

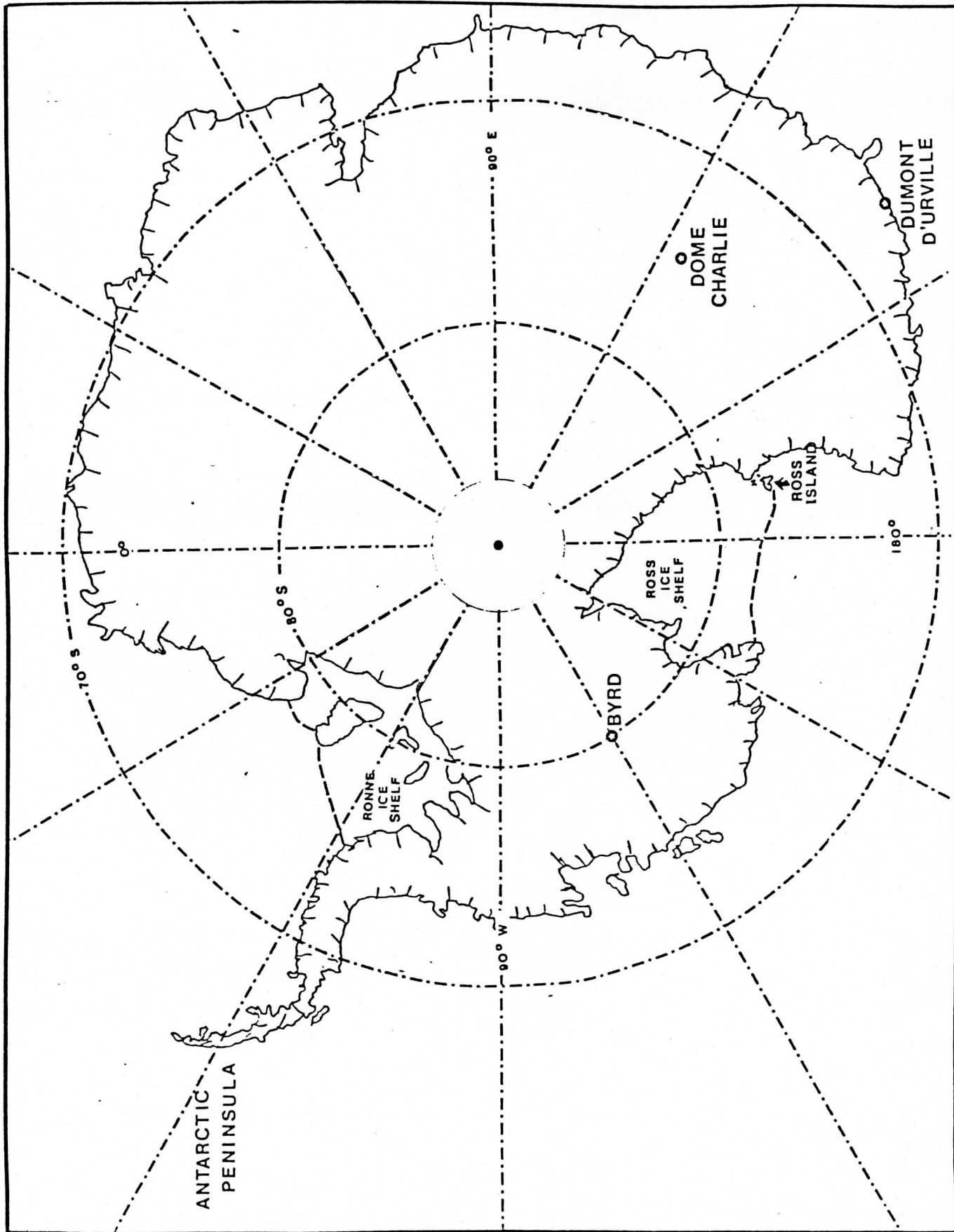

★ AWS Sites

Figure 1. Antarctica

500 kilometers

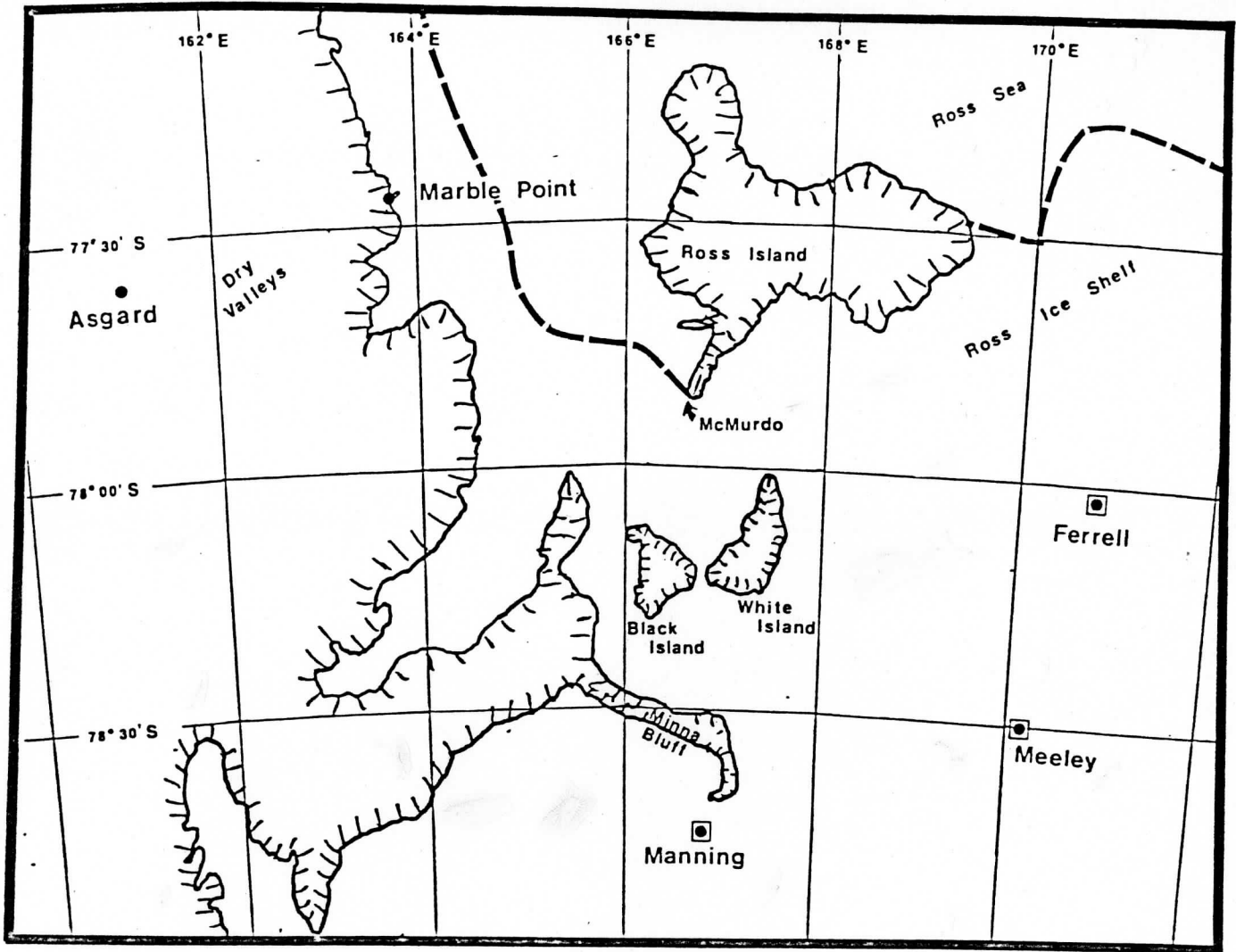

◻ installed Dec 1980

● previously installed

50 km

Automatic Weather Stations -- McMurdo, Antarctica

Figure 2.

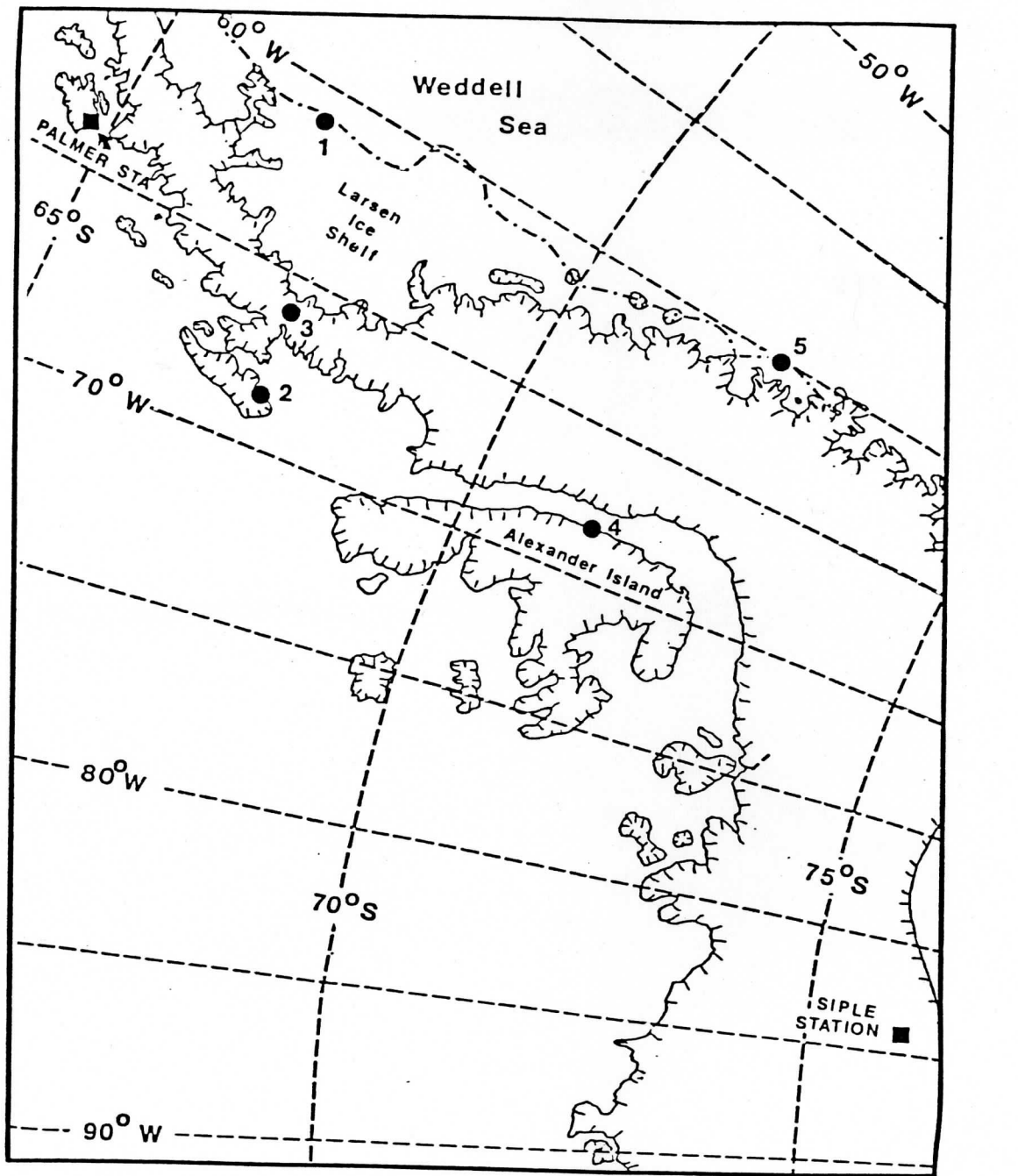

- Proposed automatic weather station sites
 - U.S. stations
- 100 kilometers

Figure 3. Proposed AWS Sites - Antarctic Peninsula

Station	Location	Elevation	Power	from McMurdo	Deployment
Byrd	80° 00' S	1530 m	RTG	1,475 km	Dec 78
8903	120° 00' W				
Dome Charlie	74° 30' S	3280 m	RTG	1,185 km	Dec 79
8904	123° 00' E				
D-10	66° 42' S	240 m	Battery	1,505 km	?
8901	139° 50' E				
D-17	?	?	Battery	?	?
8900	?				

Table 1. AWS Sites in Antarctica (not including McMurdo area)

Station	Location	Elevation	from McMurdo	Power	Humidity Sensor	Aerovane Number	Date Serviced
Asgard 8908	77°36' S 161°04' E	1,750 m	279° 135.1 km	RTG	Yes	12-78-16	9 Dec 80
Marble Point 8906	77°26'25" S 163°44'40" E	121 m	302° 83.0 km	RTG	No	3-78-010	8 Dec 80
Manning 8905	78°45'18" S 166°50'55" E	66 m	178° 100.8 km	RTG	No	?	25 Nov 80
Meeley 8915	78°30'28" S 170°10'24" E	49 m	134° 108.3 km	Battery	No	12-78-10	4 Dec 80
Ferrell 8907	78°01'55" S 170°47'30" E	44 m	104° 97.9 km	RTG	No	?	10 Dec 80

Table 2. Automatic Weather Stations - McMurdo Area

Station	Location	Elevation	Power	Deployment
#1 Ice Rise	66° 57' S 60° 36' W	50 m	Battery	To be installed Nov-Dec 81
#2 Rothera	67° 34' S 68° 08' W	17 m	Battery	To be installed March 81
#3 Spine	67° 36' S 66° 00' W	1540 m	Battery	To be installed Winter 81
#4 Fossil Bluff	71° 20' S 68° 17' W	70 m	Battery	To be installed Nov-Dec 81
#5 Butler Island	72° 04' S 60° 21' W	130 m	Battery	Rothera AWS to be redeployed to this site in Nov-Dec 81.

Table 3. Proposed AWS Sites - Antarctic Peninsula

II. FIELD WORK

1. Dome Charlie Station

ID #: 8904

Date: 21 November 1980. Julian day 326.

Time: Departed McMurdo 0030 Z. Arrived Dome Charlie 0330 Z.
Departed Dome Charlie 0415 Z. Arrived McMurdo 0730 Z.

Background: The AWS unit was installed during the 1979-80 season and has been working fine. The station is located on the featureless Antarctic Plateau at an elevation in excess of 3,000 meters. Ours was the only visit to the now-abandoned field station this season.

Equipment: A snowmobile and a Nansen sled were brought along in order to facilitate movement of personnel and equipment from the landing site to the AWS, a distance of about one-half mile. Also brought spare boom with sensors, aerovane, prop, tools, VOM meter, shovels, and camera.

Weather: Clear skies with unlimited visibility.

Trip: Ski-equipped C-130 departed McMurdo with Paschal, Smith, Evans, Savage, and about 15 "tourists" aboard. Open field landing rough due to presence of sastrugi. Pilot advised us to limit ground time to 45 minutes since aircraft engines had to remain running and fuel supply was limited.

Lt. Evans conducted radiation survey and declared site safe. Aerovane replaced. Using VOM meter found that aerovane output now going to wrong terminals indicating mismatch between aerovane and boom. Replaced boom. Now all connections ok. Temperature readings taken but altitude too great to use microbarometer.

Observations: Two uncalibrated thermometers were used.

time	height	thermometer 1	thermometer 2
0345 Z	0.3 m	-32.0 C	-30.9 C
0355 Z	1.0 m	-31.9 C	
0401 Z	0.3 m	-32.0 C	-30.0 C

estimated wind speed: 10-12 knots

estimated wind direction: not recorded

AWS Output:

time	temperature	pressure	wind
0330 Z	-31.7 C	654.1 mb	136 deg at 13.7 kt
0320 Z	-31.2 C	654.0 mb	
0310 Z	-30.9 C	653.8 mb	
0300 Z	-28.8 C	653.8 mb	
0250 Z	-28.9 C	653.8 mb	

mean wind speed: 12.7 kt

mean wind direction: 141 degrees true

signal strength: -123 dbm

- Notes:
1. Temperature observations agree well with AWS output.
 2. The unit is in good physical shape and has not been significantly buried.
 3. Pressure of 654 mb is equivalent to an altitude of approximately 3250 meters (10,660 feet).

Recommendations:

1. Bring calibrated instrument to measure wind speed.
2. Note wind direction for comparison against AWS output.

How to Find: The AWS unit is easily visible from the aircraft landing site.

2. Manning Station

ID #: 8905

Date: 25 Nov 80. Julian day 330.

Time: Departed McMurdo 2330 Z 24 Nov. Arrived old site 0000 Z.
Arrived new site 0115 Z. Arrived McMurdo 0500 Z.

Background: Old AWS site established in Nov 79 eleven km north of Minna Bluff, but has never been operational due to lack of electronics package. Tower had been damaged by torque resulting from wind-loading on tower-mounted box, and was replaced last season. Decision had been made to relocate site to an area south of Minna Bluff so that it would be situated in an undisturbed airflow for the prevailing southerly winds. RTG already in place at old site had to be moved to new site. RTG weighs 2,000 pounds.

Equipment: See Section VI. for 4-man new RTG installation equipment and weights.

Weather: Scattered cirrus 20,000 feet.

Trip: Smith, Evans, Paschal, and Savage departed in 2 helos piloted by Manning and Meeley. Set down at old site and Evans conducted RTG survey. Spent 45 minutes digging out RTG which was partially buried and severely iced up. Heavy ice picks and wrecking bars required. Snow surface here was sufficiently hard to allow helos to shut off engines and conserve fuel. Proceeded to new site with 3 passengers and all gear in one helo and 1 passenger and RTG as external load in second helo. Pilot reported that it took 100% power to lift RTG off the ground. This should be noted for future RTG moves. Also note that pilot must have special rating to transport the RTG's.

Arrived at new site and made survey. Erected tower and made station operational without difficulty. Used hand held receiver to verify that station was transmitting. Time to complete station installation about 3 hours. In order to prevent damage to tower from wind stress, a wooden frame was constructed around the electronics box and then anchored in the snow.

Observations: The two thermometers used had been calibrated the previous day using ice water. Thermometer #1 is a -30 C to + 50 C mercury-in-glass, and read 0.0 C in ice water. Thermometer #2 is a -80 C to + 20 C alcohol-in-glass, and read 0.6 C in ice water. Both thermometers were taped to the tower at a height of 2 meters.

The American Paulin System microbarometer PMB-1 was calibrated on 20 November 1980 against the aneroid barometer located in the McMurdo Weather Office. The aneroid had been calibrated by the Navy only one week earlier.

time	thermometer 1	thermometer 2	pressure
0322 Z	-8.9 C	-11.0 C	990.5 mb
0329 Z	-8.8 C	-10.9 C	990.1 mb
0355 Z	-8.5 C	-10.2 C	989.9 mb
0419 Z	-9.1 C	-11.1 C	989.9 mb
0432 Z	-8.8 C	-10.5 C	989.7 mb
0442 Z	-8.8 C	-10.9 C	989.7 mb
0456 Z	-9.1 C	-11.1 C	989.6 mb

estimated wind speed: 5-8 knots

estimated wind direction: West-northwest

AWS Output:

time	temperature	pressure	wind
0530 Z	-7.8 C	983.1 mb	309 deg at 6.9 kt
0520 Z	-8.0 C	983.3 mb	
0510 Z	-5.9 C	982.9 mb	
0500 Z	-5.8 C	982.6 mb	
0450 Z	-5.9 C	982.7 mb	

mean wind speed: 6.3 knots

mean wind direction: 309 degrees true

signal strength: -116 dbm

Notes: 1. The AWS output temperature is 3 to 5 degrees C warmer than the observed temperature.

2. The AWS output pressure is 7 mb lower than the observed pressure.

Recommendations:

1. Careful calibration checks of all parameters should be conducted next season to verify accuracy of sensors.

2. Procedures for adjusting and/or replacing inaccurate sensors should be studied so that field changes may be made next season.

How to Find: The site is located 11.8 kilometers (54.4 nautical miles) from McMurdo on a bearing of 178 degrees true. As you fly over Minna Bluff, the site is 11 nautical miles south of the highest part of the Bluff, and on a line connecting Observation Hill and the easternmost edge of Black Island.

3. Byrd Station

ID #: 8903

Date: 1 Dec 80. Julian day 336.

Time: Departed McMurdo 2030 Z 30 Nov. Arrived Byrd 2345 Z.
Visited AWS unit 0145 Z to 0215 Z 1 Dec 80. Departed
Byrd 2300 Z 1 Dec. Arrived McMurdo 0215 Z 2 Dec.

Background: The AWS unit at Byrd has been in operation since
December 78. The site is located about one mile
east of the present Byrd Surface Camp.

Equipment: Spare boom with sensors, aerovane, prop, tools,
VOM meter, showels, and camera

Weather: Low overcast skies and blowing snow on arrival.
Weather cleared after a few hours. When servicing
station, skies were 2,000 feet scattered with ice
crystals present.

Trip: Ski-equipped C-130 departed McMurdo with Evans and
Savage aboard. Visibility and horizon definition
very poor on landing. Weather cleared after a few
hours and we travelled to site via D-4 tractor
towing a sled with the people and equipment. Half
hour to reach site. AWS has been buried by drifting
snow so that height of aerovane above surface is
only about 7 feet, and electronics box is partially
buried.

Evans conducted RTG survey and declared site safe.
Aerovane replaced and VOM used to verify correct
match between aerovane and boom. Upon opening the
electronics box, found ground wire to Zener diode
not connected (opening box may have loosened it).
At the time I did not realize the significance of
the wire and did not reconnect it. Several hours
later I realized that the wire should be connected
(Zener provides constant load for RTG output) so
I returned to site and reconnected it.

Observations: Altitude too great to use microbarometer
Thermometer was a - 30 C to + 50 C mercury-in-glass.

time	temperature
------	-------------

0200 Z 1 Dec	-22.0 C
--------------	---------

estimated wind speed: 8-10 knots

estimated wind direction: Southwest

AWS Output: for 1 December 1980

time	temperature	pressure	wind
2320 Z	-18.7 C	817.3 mb	356 deg at 7.4 kt
2310 Z	-18.0 C	817.3 mb	
2300 Z	-17.8 C	817.2 mb	
2250 Z	-15.7 C	817.2 mb	
2240 Z	-15.3 C	817.3 mb	

mean wind speed: 7.4 knots

mean wind direction: 011 degrees true

signal strength: -114 dbm

- Notes: 1. Accurate comparisons between observed parameters and AWS output not possible at this time due to lack of AWS output.
2. The large difference between observed and AWS output wind direction is reason for concern. Of course the AWS output is for 21 hours later than the observed data, and the wind may have shifted.

Recommendations:

1. Careful check of all parameters, particularly wind direction, should be made next visit.
2. Drift rate is high and station is already partially buried. A new tower section needs to be added in order to increase the height of the aerovane above the surface. Also, the electronics box needs to be re-positioned higher up on the tower. Evans and Smith will attempt to return to the station this season to do this work.

How to Find: The site is located 4500 feet (1370 meters) east of Byrd Surface Camp. First drive to the aurora tower (the aurora tower and the old balloon inflation tower east of it are the two wooden buildings visible above the snow over the main complex at old Byrd Station). Drive east from the aurora tower past the VLF lab site (40 foot tower with hatch and winch). Continue east another 2000 feet past the VLF tower to the AWS site.

4. Meeley Station

ID #: 8915

Date: 4 Dec 80. Julian day 339.

Time: Departed McMurdo 0100 Z. Arrived site 0140 Z.
Departed site 0400 Z. Arrived McMurdo 0440 Z.

Background: This is a new station located 108 km ESE of McMurdo. In place of an RTG, 9 gel-cell batteries connected in parallel are used to provide the necessary 12 volts DC. The cells should last for one year, and are rechargeable. It is planned to install solar panels next season to provide a charging current for the batteries.

Equipment: Since the batteries weigh about 250 pounds, only 3 men could go. See section VI for 3-man battery station equipment and weights.

Weather: Skies were overcast and winds were between 20 and 25 knots from the Southwest.

Trip: Helo piloted by Meeley departed McMurdo with Evans, Savage, and Navy enlisted man aboard. Station installation difficult due to cold, high wind, hard snow surface (difficult to dig) and time pressure. Calculator used in surveying froze up so had to estimate compass positions based on predicted bearing to Mt. Erebus. Consequently wind direction may be inaccurate by as much as 20 degrees. However, accurate site survey achieved by noting all parameters and adding in necessary correction factor later.

Station installation proceeded ok. Used VOM to verify aerovane wiring and used hand held receiver to check that station was transmitting. Batteries were buried a few feet from tower with charging harness for solar cells installed and tied to tower for accessibility next year.

Observations: None taken due to insufficient time.

AWS Output:

time	temperature	pressure	wind
0520 Z	-12.3 C	977.3 mb	208 deg at 18.0 kt
0510 Z	-12.3 C	977.3 mb	
0500 Z	-12.3 C	977.4 mb	
0450 Z	-12.3 C	977.5 mb	
0440 Z	-12.3 C	977.7 mb	

estimated wind speed: 19.0 knots

estimated wind direction: 225 degrees true

signal strength: -116 dbm

Recommendations:

1. The site should be resurveyed next visit to accurately determine the compass points, and the aerovane should be realigned if necessary.
2. Temperature, pressure, and wind observations should be taken in order to establish accurate calibrations.
3. Since this station is distant from any landmarks, it will be difficult to find. Navigation is difficult around McMurdo due to high-latitude effects on the compass, and pilots usually have to rely on dead-reckoning. A radio-direction finder would be very helpful in locating all the ice-shelf stations in the future.

How to find: The station is located 58.5 nautical miles from McMurdo on a bearing of 134 degrees true. McMurdo air-traffic control ("Mac Center") has a radar and they can vector the helicopter along this bearing if prior arrangements are made. Using the radar and estimating distance travelled by knowledge of air speed and elapsed time, the pilot should be able to get within a few miles of the station. Then its a matter of hunting around to find it. It is helpful to land and scan the horizon. The tower of the AWS should be visible against the sky if within a few miles.

5. Marble Point Station

ID #: 8906

Date: 8 December 1980. Julian day 343.

Time: Departed McMurdo 0600 Z. Arrived Marble Point 0630 Z.
Departed Marble Point 0730 Z. Arrived McMurdo 0800 Z.

Background: The station has been in operation since November 1978 and has been working well.

Equipment: See section VI for 3-man visit to already established site.

Weather: Weather had been poor all day and we were uncertain if we would be able to go at all. Estimated ceiling 3000 feet with stratus but good visibility below the ceiling. Would have liked to go to Asgard after finishing at Marble Point, but ceiling was prohibitive.

Trip: Evans, Smith and Savage aboard. Nice flight over the Sound. Found site easily and set down in clear area about 100 meters away. Evans surveyed RTG. Replaced aerovane and confirmed proper match with boom. Verified that station was transmitting using hand-held receiver.

Observations: Thermometer was a calibrated -30 to +50 C mercury-in-glass. Microbarometer was Paulin PMB-1.

time	temperature	pressure
0700 Z		969.5 mb
0704 Z	-1.2 C	
0707 Z	-1.6 C	

estimated wind speed: 10-12 knots

estimated wind direction: South

AWS Output:

time	temperature	pressure	wind
0710 Z	0.0 C	968.0 mb	152 deg at 10.5 kt
0700 Z	0.0 C	968.1 mb	
0650 Z	0.1 C	968.1 mb	
0640 Z	0.1 C	967.8 mb	
0630 Z	0.1 C	967.7 mb	

mean wind speed: 10.5 knots

mean wind direction: 162 degrees true

signal strength: -118 dbm

How to Find: The site is located 2.5 kilometers southwest of the tip of Marble Point, near the top of the 122 m hill shown on the USGS map of Ross Island. If the site cannot be found, fly inland into the valley near the base of the Wilson Piedmont Glacier. Then flying at low level the tower can be seen outlined against the sky.

6. Asgard Station

ID #: 8908

Date: 9 December 1980. Julian day 344.

Time: Departed McMurdo 0700 Z. Arrived site 0800 Z.
Departed site 0900 Z. Arrived McMurdo 1000 Z.

Background: This AWS unit was originally located in Beacon Valley to the south. It was relocated to its current position during the 1979-80 season. Dr. Friedmann has a biological experiment at this site and the AWS data is used by his group. For this reason the unit has a humidity sensor in addition to the regular sensors.

Equipment: See section VI for 3-man visit to already established station.

Weather: On arrival, scattered clouds with about 2 inches of fresh powder snow on the ground. During our stay at the station clouds moved in from the northwest until sky was low overcast with light snow showers and abundant ice crystals.

Trip: Smith, Evans, and Savage departed in helo piloted by Ferrell. Beautiful trip up Taylor Valley. Found site without difficulty, landed, and shut down helo. Evans conducted radiation survey. Replaced aerovane and verified correct match to boom. Verified transmitter output.

Observations: Calibrated -30 to +50 C mercury-in-glass thermometer used. Altitude (1,750 meters) too high to use microbarometer.

time	temperature	relative humidity
0819 Z	-10.2 C	
0833 Z	-11.8 C	
0848 Z	-10.5 C	100%

estimated wind speed: calm

estimated wind direction (direction which aerovane was pointing): Northwest

AWS Output:

time	temperature	pressure	wind
0830 Z	-7.2 C	800.3 mb	008 degrees at 0.0 kt
0820 Z	-8.8 C	800.3 mb	
0810 Z	-8.4 C	800.2 mb	
0800 Z	-8.0 C	800.2 mb	
0750 Z	-9.4 C	800.2 mb	

mean wind speed: 0.0 knots
mean wind direction: 315 degrees true
signal strength: -115 dbm
humidity sensor voltage: 4.6 volts

Notes: 1. AWS output temperature 4 to 5 degrees warmer than observed temperature.

How to Find: Station is located adjacent to identifiable landmarks and can easily be found using topographic maps.

7. Ferrell Station

ID #: 8907

Date: 10 December 1980. Julian day 345.

Time: Departed McMurdo 0700 Z. Arrived old White Island site 0730 Z. Arrived new site 0900Z. Arrived McMurdo 1130 Z.

Background: Old site installed in November 1978 but never operational due to lack of electronics package. Decision had been made to relocate the station farther out on the Ice Shelf.

Equipment: See section VI for 4-man new RTG installation.

Weather: Only thinly scattered clouds while working at old site, but bank of low clouds approached rapidly from east as we were installing new station. Low ceiling present by the time we were finished, requiring a hasty departure.

Trip: Smith, Savage, Savage, and Navy enlisted departed McMurdo in helo piloted by Ferrell and arrived at old site after 15 minutes of searching for it. Finally found it by landing and scanning horizon for tower. Station was half buried and RTG really frozen in solid. Helo dropped us off and returned to McMurdo. Took us an hour digging out RTG and tower.

Helo returned and carried us and gear out to new site then returned to fetch RTG. We installed station in great haste due to anxiety over rapidly deteriorating weather. Site survey hampered by decreasing visibility and should be repeated next visit for verification. Helo returned with RTG, landed, and shut down. We finished installation and departed with ceiling down to 500 feet.

Observations: No temperature or pressure observations taken due to time pressure.

estimated wind speed: 2-5 knots

estimated wind direction: South

AWS Output:

time	temperature	pressure	wind
1140 Z	-8.0 C	985.6 mb	205 deg at 7.5 kt
1130 Z	-8.2 C	985.5 mb	
1120 Z	-6.3 C	985.5 mb	
1110 Z	-6.2 C	985.5 mb	
1100 Z	-6.4 C	986.9 mb	

mean wind speed: 3.7 knots
mean wind direction: 189 degrees
signal strength: -117 dbm

Recommendations:

1. Verify site survey.
2. Take calibration readings for temperature and pressure.
3. This station is going to be difficult to find and a radio direction finder would be helpful.

How to Find: The station is located 52.9 nautical miles from McMurdo on a bearing of 104 degrees true. As discussed previously, use the McMurdo radar to help guide the helo along the correct bearing, and then begin searching for the station once you have gone out the required distance.

III. SURVEYING PROCEDURES

Accurate surveying procedures are required for two purposes: to determine the true compass at each site in order to properly align the aerovane, and to determine the exact location of the new station from sightings on known landmarks.

The true compass is determined by taking a sun sight with a theodolite and then setting the theodolite's azimuth scale to the known azimuth of the sun, which is a function of latitude, longitude, time of day, and time of year. The latitude and longitude can be estimated within 10 minutes of arc from dead-reckoning, and the time is known precisely from a high-quality watch. Given these input data, the card-readable HP-67 calculator has a prerecorded program as part of its Navigation Pac which will compute the sun's azimuth. An error of 12 nautical miles in assumed position would introduce an error of only 26 minutes of arc in the computed azimuth.

Now the cardinal points of the compass can be marked. The theodolite is set to read exactly north and a flag is positioned to indicate this direction. The other cardinal points are marked in a similar fashion.

In order to properly align the aerovane it is first necessary to insure that when installing the tower one of the sides is in line with the north-south flags. Then when installing the boom, the end with the antenna should be towards north while the end with the aerovane is towards the south, with the boom fastened to the tower along the side oriented north-south.

The theodolite can now be used to take sights on known landmarks. Using a topographic map, these sights can be used to determine the exact position of the station. The HP-67 also has a prerecorded program in the Surveying Pac which can be used to aid in plotting lines of position and intercepts for very accurate determination of the station location.

IV. INSTALLATION PROCEDURES

1. Site survey: As explained in the preceding section, a sun sight is taken, the compass points are flagged, and landmark bearings are taken. Only after all this is complete may the theodolite be removed and the tower hole dug exactly where the theodolite had been.
2. Tower installation: The hole should be 2 to 3 feet deep. It is most important to turn the tower so that one of the three sides is in line with the north-south flags. Once the tower is properly positioned, the hole is packed with snow and the sides of the tower are guyed using plywood "deadmen" to anchor the lines in the snow. Cable clamps are used to set proper tension on each line.
3. Boom installation: The boom is installed using U-bolts. Then the aerovane is installed using the plug-in connector on the boom.
4. Verification of aerovane wiring: See Figure 4 for details of aerovane/boom wiring. The VOM meter is used to verify connections.
5. Power hook-up: The RTG or battery power cable is installed using a plug-in connector. Then the cover of the electronics box is opened and wire #1 is connected to terminal #1 thereby supplying power to the transmitter.
6. Verification: The hand-held receiver is now used to verify that the station is transmitting. The transmissions occur once every 200 seconds and last only a few seconds.

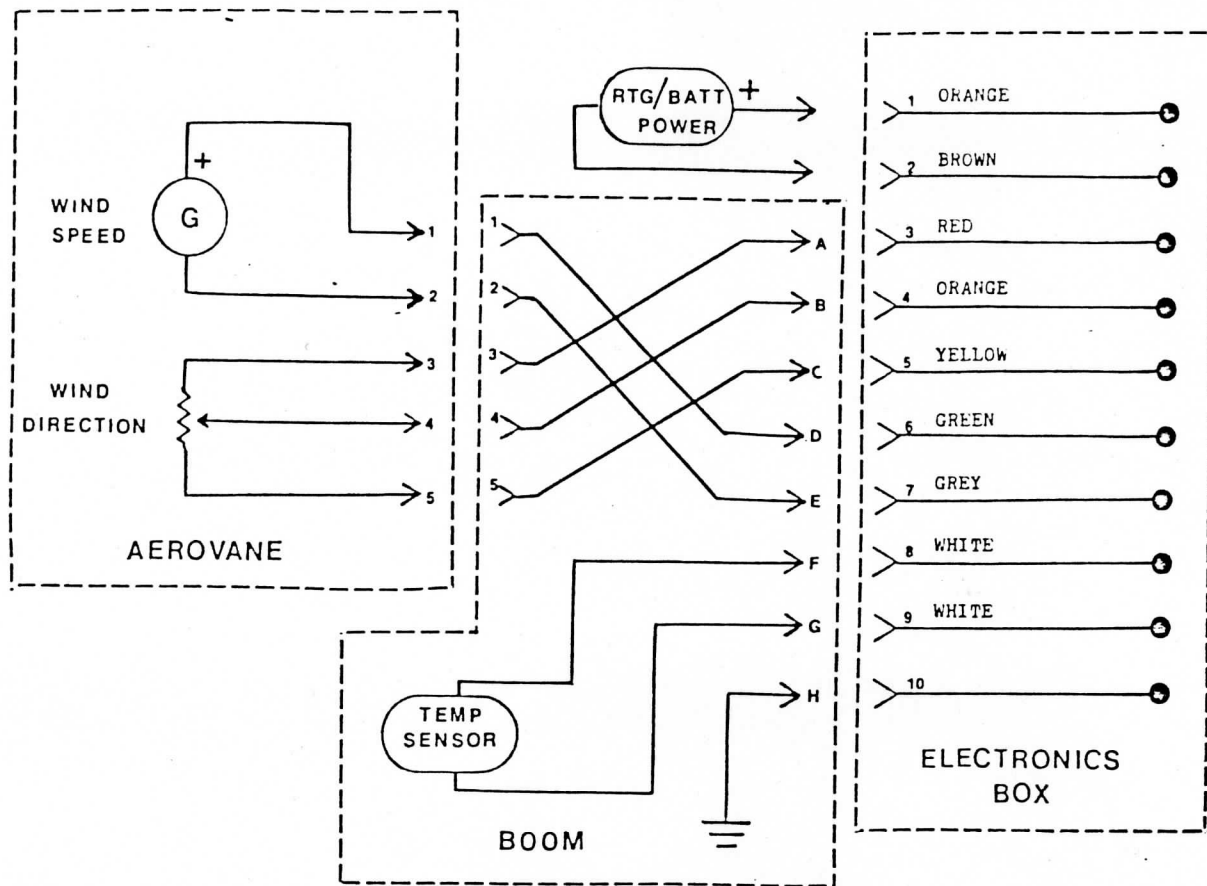

1. All booms and aerovanes at the AWS sites and in McMurdo were checked and if necessary adjusted to conform with this wiring configuration.
2. Wind direction check: There should be a constant 10,000 ohm resistance between pins 3 and 5 on the aerovane. The resistance should increase from 0 to 10,000 ohms for a clockwise rotation of the aerovane (as viewed from above) when an ohmmeter is connected to pins 4 and 5 on the aerovane.
3. Wind speed check: - Pin 1 should be positive with respect to pin 2 of the aerovane for a counterclockwise rotation of the prop as viewed from the front.

Figure 4. Wiring Convention

V. AEROVANES

The aerovane used in the AWS unit is the Aerovane Wind Transmitter, Model 120, Part #510072-7 manufactured by the Bendix Corporation Environmental and Process Instrument Division, Baltimore, MD. The instruments are modified for use in the AWS units by the removal of the wind direction synchros and replacement with a 0 to 10,000 ohm potentiometer.

The McMurdo Weather Office has the necessary equipment for testing the generator output of the aerovanes. The generator should produce 9.20 volts when spun at 1,800 rpm with an output load of 1150 ohms. There is an adjustment screw which is used to adjust the output voltage as necessary. The generator brushes should be inspected and cleaned before performing this test.

I was unaware that the aerovanes had not been tested until after the trips to Dome Charlie and Manning. For the remaining five stations, the aerovanes were disassembled, inspected, cleaned, spin-tested, and adjusted as necessary prior to installation.

One of the aerovane generators would not produce the necessary voltage even with maximum adjustment, and was brought back to the University of Wisconsin for repair. The 4 aerovanes in storage in McMurdo have not yet been tested.

A simple test described in the manufacture's instruction book was performed to determine if the bearings were in order. This involved weighting the tail with a coin and verifying that the aerovane revolved a sufficient amount. All units passed.

VI. EQUIPMENT FOR HELO TRIPS

The maximum internal cargo load for the Navy helicopters in McMurdo is 1,500 pounds. A written weight estimate is required with each helicopter request so that fuel requirements can be planned. Each passenger is counted as 200 pounds regardless of actual weight.

1. 3-man trip to already established station

item	weight	number	total weight
survival bag	46 lbs	1	46 lbs
sleeping bag	16 lbs	3	48 lbs
h.f. radio set	25 lbs	1	25 lbs
radiation survey set	20 lbs	1	20 lbs
tool kit with VOM meter	25 lbs	1	25 lbs
sensor boom	15 lbs	1	15 lbs
aerovane	10 lbs	1	10 lbs
prop	1 lbs	1	1 lbs
rope	10 lbs	1	10 lbs
box lunch	2 lbs	3	6 lbs
personal gear	15 lbs	3	45 lbs
passenger	200 lbs	3	600 lbs
signal mirror		1	
smoke grenades		3	
TOTAL			851 lbs

2. 4-man new RTG installation

Add the following to the above list:

sleeping bag	16 lbs	1	16 lbs
survival bag	46 lbs	1	46 lbs
passenger	200 lbs	1	200 lbs
electronics box	88 lbs	1	88 lbs
antenna	5 lbs	1	5 lbs
tower	60 lbs	1	60 lbs
RTG power cable	12 lbs	1	12 lbs
RTG lifting bar	45 lbs	1	45 lbs
theodolite and tripod	47 lbs	1	47 lbs
shovels	10 lbs	3	30 lbs
picks	10 lbs	2	20 lbs
wrecking bar	15 lbs	2	30 lbs
flags		5	
bamboo poles		4	
cable clamps		6	
U-bolts		2	
Total from 1.			851 lbs
TOTAL			1450 lbs

3. 3-man new battery station installation

Add the following to the equipment in I.

item	weight	number	total weight
battery boxes	90 lbs	3	270 lbs
electronics box	88 lbs	1	88 lbs
antenna	5 lbs	1	5 lbs
tower	60 lbs	1	60 lbs
battery power cable	12 lbs	1	12 lbs
theodolite and tripod	47 lbs	1	47 lbs
shovels	10 lbs	2	20 lbs
picks	10 lbs	1	10 lbs
flags		5	
bamboo poles		4	
cable clamps		6	
U-bolts		2	
tape			
Total from 1.			851 lbs
TOTAL			1363 lbs

VII. INVENTORY

AWS equipment inventory as of 11 December 1980 following the completion of the 1980 field season

1. Berg Field Center, McMurdo

- 4 aerovanes
- 5 props
- 3 antennas
- 2 boom with temp sensor and aerovane mount
- 1 10 foot tower with base
- 1 damaged 10 foot tower with base
- 1 sensor cable with aerovane mount and temp sensor.
spare cable clamps, U-bolts, plywood deadmen, rope,
assorted tools and hardware.

2. Cargo Hill, McMurdo

- 2 booms without sensor cables
- 14 box mounting brackets
- 1 blue electronics box with foam and cables but no electronics
- 3 10-foot towers
- 2 3-foot orange tower extensions
- 4 metal tower bases
- 7 plywood tower base supports

3. University of Wisconsin

- 1 aerovane with damaged generator
- 1 Paulin PMB-1 microbarometer

4. On loan to Dr. Friedmann, McMurdo

- 1 VOM meter
- 1 infrared thermometer
- 5 thermometers

VIII. NOTES ON AWS CALIBRATION DATA

Table 4 presents a summary of observed and transmitted data from the seven AWS stations. There are a number of points concerning this data that should be emphasized.

The time of the transmitted data is only known to an accuracy of 5 minutes as a result of the way in which the satellite readout system operates. In many cases the time of the observed data does not coincide with the time of the transmitted data, making accurate comparisons impossible. Temperature observations were made using thermometers that often did not agree with one another by as much as 4 degrees Celsius. The thermometers were read near ground level while the temperature sensor on the AWS unit is located on the top of the 10-foot tower. The thermometers may have been influenced by the body heat of the person reading them. Wind speed and direction were estimated without the aid of instruments. Finally, no temperature or pressure observations were taken at two of the new installations due to time pressure.

For these reasons the observed data in Table 4 should not be considered as calibration data but rather as comparative data to be used in verifying that the sensors are "in the ballpark".

Hopefully the lessons learned this past season will be applied this coming season to insure that accurate calibration data is obtained. Specific recommendations on how to achieve this are contained in the next section.

Station	(Z) Time		Temperature (°C)		Pressure (mb)		Wind Speed (kt)		(degrees true) Wind Direction	
	obs	AWS	obs	AWS	obs	AWS	obs	AWS	obs	AWS
Dome Charlie 8904	0345	0330	-31.5	-31.7	(1) 654.1		11	12	(2)	SE
Manning 8905	0456	0450	-10.1	-5.9	989.6	982.7	7	6		WNW NW
Byrd 8903	0200 1 Dec	2240 1 Dec	-22.0 (3)	-15.3	(1) 817.3		9	7		SW N (3)
Meeley 8915	(2)	0500	(2)	-12.3	(2) 977.4		23	19		SW SW
Marble Point 8906	0700	0700	-1.2	0.0	969.5	968.1	11	11		S SSE
Asgard 8908	0819	0820	-10.2	-8.8	(1) 800.3		0	0		NW NW
Ferrell 8907	(2)	1120	(2)	-6.3	(2) 985.5		4	4		S S

(1) Altitude too high to use PMB-1 microbarometer

(2) Not Recorded

(3) Note 21 hour time difference between observation and AWS data

Observed wind speeds and directions estimated without the aid of instruments.

Observed temperature represent average value when more than one thermometer was used.

Table 4. Summary of AWS Calibration Data

IX. RECOMMENDATIONS

Recommendations for obtaining accurate calibration data are as follows:

1. Recording instruments designed to measure temperature, pressure, and wind speed should be obtained and modified for use in cold weather.
2. An electronic device that could be used in the field to obtain a direct readout of the AWS sensors should be fabricated.
3. Calibration devices should be obtained that can effect on-site testing of the pressure and temperature sensors over the range of expected values. A U-tube manometer could be used to place a pressure difference 10 millibars across the pressure sensor. Dry ice could be used as a reference point for very cold temperatures and ice water could be used to obtain a calibration reading at 0 degrees Celsius.
4. Wind direction accuracy can be verified by using a theodolite to take a sun sight in order to confirm aerovane orientation. The aerovane could then be turned through the compass while the AWS output was observed.
5. The microbarograph obtained must be capable of recording pressures as low as 630 millibars.

Other recommendations previously stated in this report are summarized here:

1. A radio direction finder for use in locating the Ice Shelf stations should be obtained. This could simply be a directional antenna attached to the hand-held receiver we already have, or it may involve obtaining more sophisticated equipment.
2. Solar cells should be installed at Meeley Station (8915) for charging of the batteries.
3. The problem of inaccurate pressure readings as the result of wind effects on the pressure sensors should be investigated.

BLANK SHEET
AFTER THIS
PAGE
(145-146)

VI. Annual Summary Article (published in the Antarctic Journal of the U.S., Vol XVI, No. 5.

Automatic weather stations, 1980-1981

Charles R. Stearns and Michael L. Savage

Department of Meteorology
University of Wisconsin
Madison, Wisconsin 53706

Automatic weather stations (AWS) are deployed in Antarctica in support of research on barrier and foehn winds (Antarctica Peninsula), mesoscale wind flow (McMurdo), and katabatic winds (Dumont d'Urville, 66°40'S 140°01'E, and Dome C). The data also will provide an increased database for antarctic forecasters and southern hemispheric numerical models.

The AWS units measure air temperature, air pressure, wind speed, and wind direction at a height of 3 meters above the surface. The data are transmitted to polar orbiting satellites for storage and retransmission to ground stations in McMurdo and in the United States (Renard and Salinas 1977; Savage and Stearns 1981).

Prior to austral summer 1980-81, six AWS units had been deployed. During that season, four additional stations were installed (see table).

The AWS units in the Antarctic Peninsula region are being installed by the British Antarctic Survey from Rothera. Four AWS units were shipped to Rothera in the fall of 1980 and the first unit, 8917, became operational at Rothera on 31 March 1981. The second unit, 8919, became operational on 25 May 1981. All units will be operated at Rothera for 1 month for comparison to local meteorological observations before final deployment around the peninsula (figure 1).

In the McMurdo area, AWS units at Marble Point and Asgard have been operating since austral summer 1978-79. During austral summer 1980-81, Michael Savage supervised the deployment of three additional AWS units in an arc of approximately 100-kilometer radius south-southeast of McMurdo (figure 2). The AWS at Asgard and Marble Point, as well as those at Byrd and Dome C, were visited in order to replace the Bendix aerovanes.

In the Dumont d'Urville area, AWS 8916 was deployed at D-57 by a French traverse party. AWS 8901 at D-10 continues to operate properly, but AWS 8900 at D-17 failed in June 1980 after 6 months of operation.

AWS data are received in real-time from the satellite at the McMurdo Weather Office using the TIROS information processor (TIP) decoder designed and installed by Stanford University scientists. On at least one occasion in 1980-81 an LC-130 flight from Christchurch, New Zealand, to McMurdo was canceled because the TIP readout indicated that a "Herbie" (blowing snow) was moving toward McMurdo and would make landing at McMurdo difficult or impossible.

The AWS data collected by the satellite are delivered to the University of Wisconsin at monthly intervals. The raw data are converted to scientific units and stored on magnetic tape for distribution to the principal investigators (R.J. Renard, Naval Postgraduate School - McMurdo area; G. Wendler, University of Alaska - Dome C to Dumont d'Urville; and C. Stearns, University of Wisconsin - Antarctic Peninsula). Three-hourly observations and monthly summaries are prepared for each station for use by those involved with the AWS program.

This work is supported by National Science Foundation grant DPP 79-25040. The design, development, and early deployments of the AWS were done by members of the Radio-science Department, Stanford University, under the direction of Allen M. Peterson. John Katsufakis and Evans Paschal of Stanford installed the TIP decoder at McMurdo and assisted in the installation of AWS 8905 on the Ross Ice Shelf, and their help is gratefully acknowledged. The support of the British Antarctic Survey through Charles Swithinbank and Victor August, who is carrying out the AWS deployments from Rothera, is greatly appreciated. The efforts of Joseph Boissiere of the Expeditions Polaires Francaises in deploying D-57 and the assistance of LTCDR Brad Smith and LT Bob Evans of the Naval Support Force Antarctica in the deployments around McMurdo also is appreciated.

References

- Renard, R.J., and Salinas, M.G., 1977. The history, operation, and performance of an experimental automatic weather station in Antarctica (Technical Report NPS-63Rd77101). Monterey, Calif.: Department of the Navy, Naval Post Graduate School.
- Savage, M.L., and Stearns, C.R., 1981. Automatic weather stations in Antarctica. In N. Young (Ed.), Conference proceedings, Antarctica: Weather and climate (University of Melbourne, 11-13 May 1981). Melbourne: University of Melbourne.

Current and proposed aws deployments in Antarctica. Two units currently in operation at Rothera will be deployed to other sites

Name	ID number	Location	Elevation (meters)	Deployment
Current aws deployment				
Marble Point	8906	77°26'S 163°45'E	121 m	1978-79
Asgard	8908	77°36'S 161°04'E	1,750 m	1978-79
Manning	8905	78°45'S 166°51'E	66 m	1980-81
Meeley	8915	78°30'S 170°10'E	49 m	1980-81
Ferrell	8907	78°02'S 170°48'E	44 m	1980-81
D-10	8901	66°42'S 139°50'E	240 m	1979-80
D-17	8900	66°44'S 139°42'E	438 m	1979-80
D-57	8916	68°12'S 137°32'E	2,064 m	1980-81
Dome C	8904	74°30'S 123°00'E	3,280 m	1979-80
Byrd	8903	80°00'S 120°00'W	1,530 m	1978-79
Proposed aws deployment				
Ice Rise	—	66°57'S 60°36'W	50 m	Dec. 1981
Spine	—	67°36'S 66°00'W	1,540 m	Winter 1981
Fossil Bluff	—	71°20'S 68°17'W	70 m	Dec. 1981
Butler Island	—	72°04'S 60°21'W	130 m	Dec. 1981

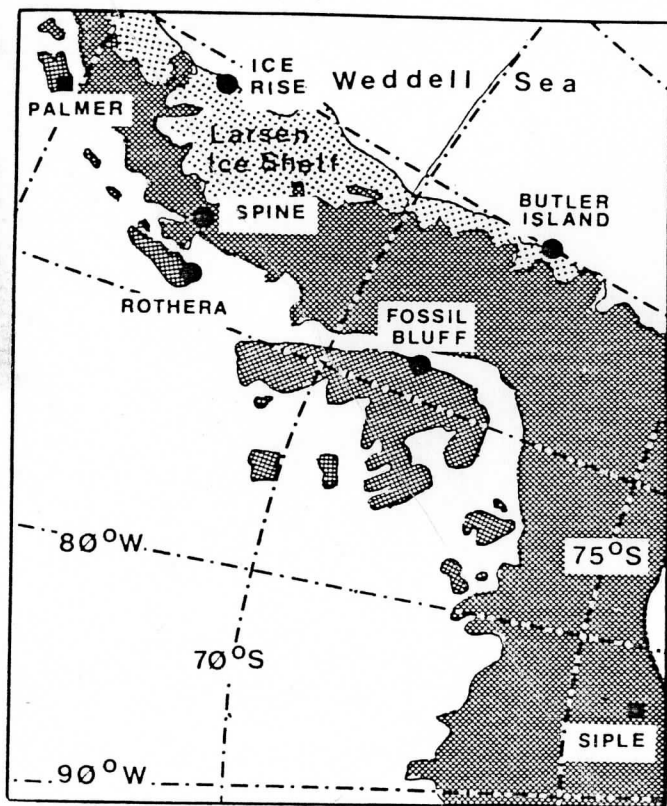

- Proposed AWS sites
- Permanent U.S. Stations

Figure 1. Proposed aws deployment—Antarctic Peninsula.

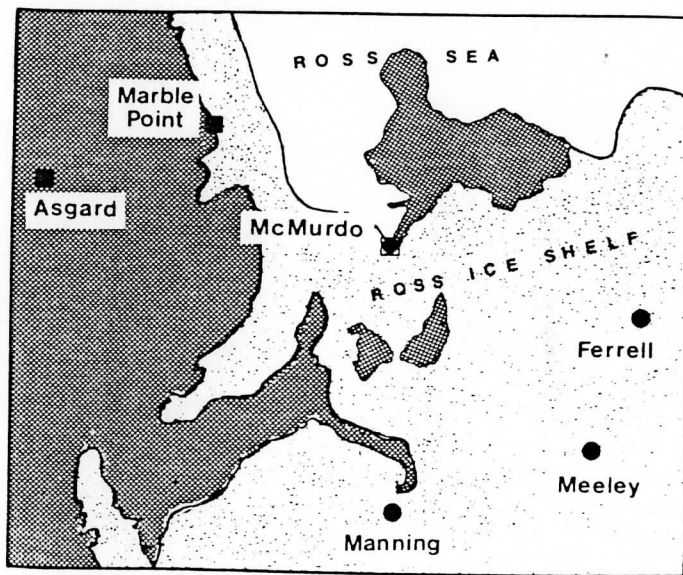

- AWS installed 1980-81 season
- AWS installed 1978-79 season
- ⊠ year-round manned station

Figure 2. AWS deployment—Ross Island area.

NO BACK UP